

AKIRA

makes life better

Air Conditioner Service Manual



Большая библиотека технической документации

<https://splitsystema48.ru/instrukcii-po-ekspluatácii-kondicionerov.html>

каталоги, инструкции, сервисные мануалы, схемы.

MODEL:AC-S1388CHD

CONTENTS

TECHNICAL SPECIFICATION.....	4
APPEARANCE & PARTS NAME.....	5
SYSTEM DAIGRAM.....	6
ELECTRIC WIRING DIAGRAM.....	7
DISASSEMBLY PROCEDURES.....	9
EXPLODED VIEW AND PARTS LIST.....	18
GUIDE FOR INSTALLATION.....	22
CARE AND MAINTENANCE.....	29
MULFUNCTION ANALYSIS.....	30

TECHNICAL SPECIFICATION

Split type model	12000 btu
Cooling Capacity (Btu/h)	12000
Rated Input (w) - cooling	1350
Moisture Removal (L/H.r) - High	1.4
Air Circulation (CMH Max)	500
EER for Cooling (W/w)	2.6
COP for Heating (w/w)	2.8
Power Supply	
Volt/Phase/Hz	220-240V/1/50Hz
Rated Current (A) - Cooling	6.3
Noise (dB (A)) (indoor) H/M/L	39-37-35
- (Outdoor)	54
System	
Refrigerant	R22
Compressor Brand	Sanyo/Highly
Hydrophilics fins (indoor/outdoor)	Yes
Grooved copper tubes	Yes
Liquid Pipe Diameter (mm)	6.35
Gas Pipe Diameter (mm)	12.7
Features	
Remote Controller	Yes
Removable & Washable Panel	Yes
Washable Filter	Yes
Number of Speed Control (ex : Auto, 1, 2, 3)	Yes
Number of working mode (ex : Cool/Heat/Smart/ Fan / Dehumidify = 5 modes)	Yes
Vertical Auto Swing Louver	Yes
Horizontal Manual Louver	Yes
Sleep Operation	Yes
Smart Function (Auto mode)	Yes
Anti cold air preventive function	Yes
Auto diagnosis	Yes
L.E.D or LCD display on indoor unit	L.E.D
Remote control wall holder	No
Other (Please specify)	
Dimensions & Weight	
Dimensions WxHxD (mm) - Indoor	760*245*188
- Outdoor	660*435*265
Net Weight - Indoor / Outdoor (kg)	9 / 28
Gross Weight - Indoor / Outdoor (kg)	12 / 32

The technical data are subject to change without notice. Please refer to the nameplate of the unit.

APPEARANCE & PARTS NAME

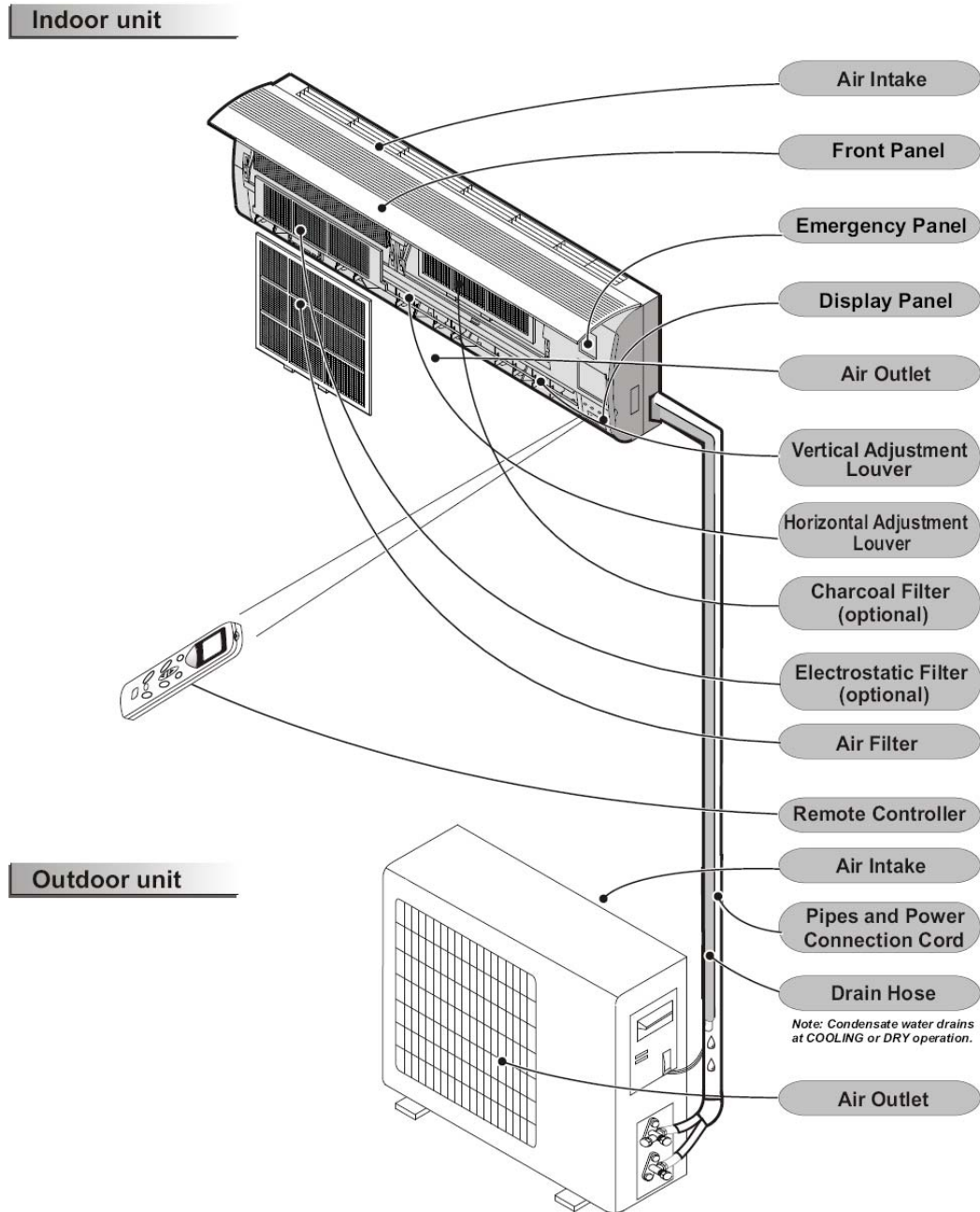

NOTE

- The drawing in this book may vary from your model. They are designed to show the different features of all models covered by this book, Your model may not include all features.

SYSTEM DIAGRAM

A) REFRIGERANT FLOW DIAGRAM

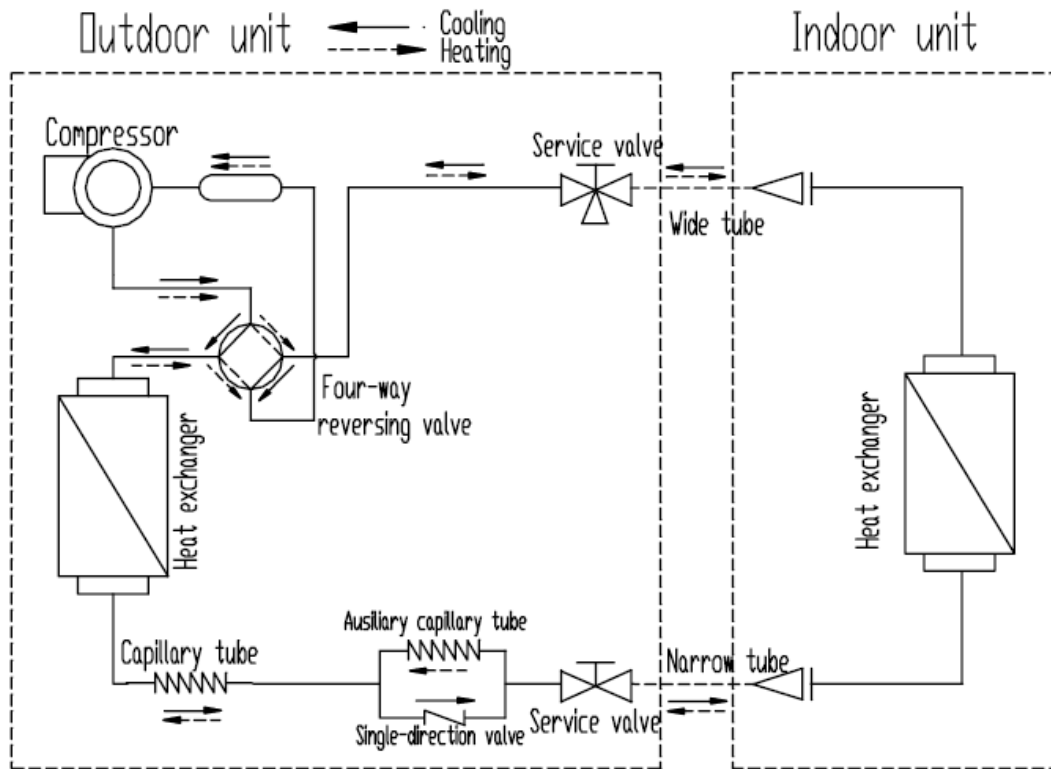

Thermal insulating of refrigerant pipeline

To prevent heat loss and condensed water from dropping on the floor, the wide and narrow tube of air conditioner should be wrapped with thermal insulating materials. For using capillary tube, and the tubes are in low temperature, the thickness of thermal insulating materials shall be more than 8mm

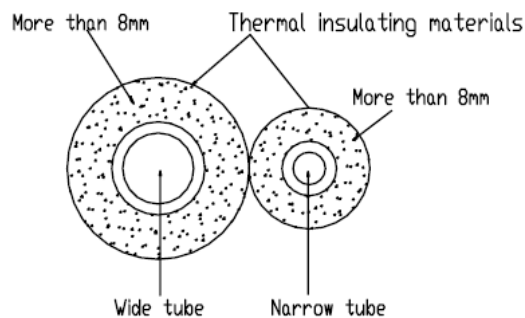

Narrow tube	Φ 6.35 mm (1/4")
Wide tube	Φ 9.52 mm (3/8") Φ 12.7 mm (1/2")

B) ELECTRICAL WIRING DIAGRAM – Outdoor Unit

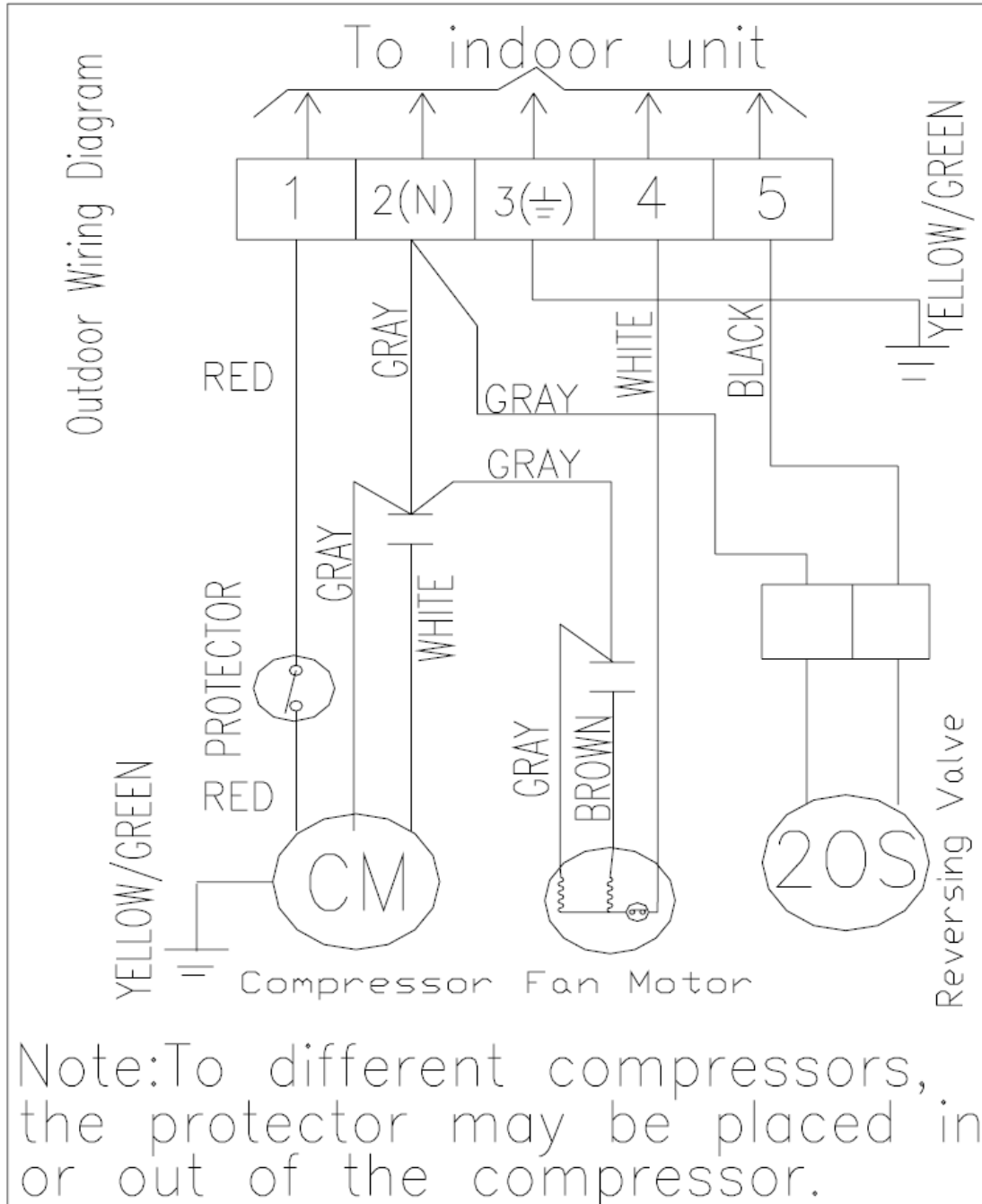

C) ELECTRICAL WIRING DIAGRAM – Indoor Unit

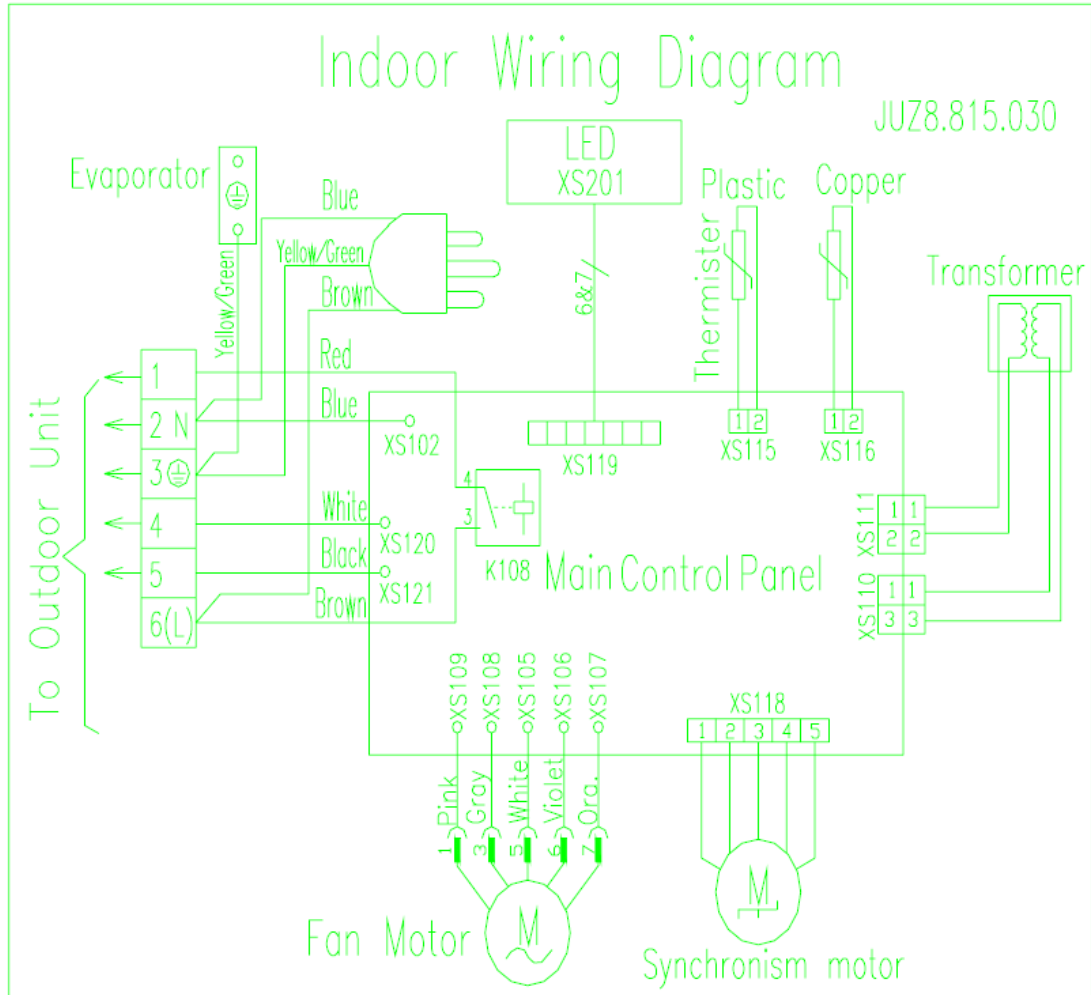

DISASSEMBLY PROCEDURES

INDOOR UNIT

Operation procedures/pictures

Disassemble the front panel

Raise up the front panel, take out the front panel. (As shown in Fig.8-1)

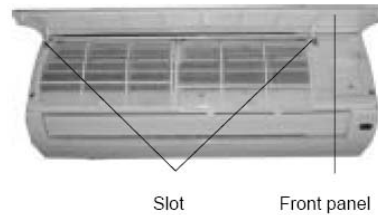

Fig. 8-1

Remove filter and wire-pressed clamp

To remove the filter, and screw off 1pc bolt which fixed the wire-pressed clamp to disassemble the wire-pressed clamp. (As shown in Fig.8-2)

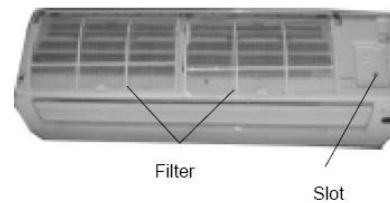

Fig. 8-2

Disassemble the guide louver

Disassemble the big guide louver and small guide louver. (As shown in Fig. 8-3)

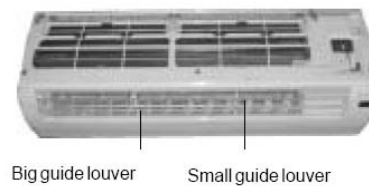
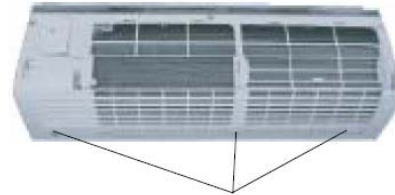

Fig. 8-3

||||||| **Disassemble the front case**

To loose the clasp (As shown in Fig.8-4)

To remove the screw cap, to loose 3pcs screw, raise it up, disassemble the front case. (As shown in Fig.8-5)



Clasp

Fig. 8-4

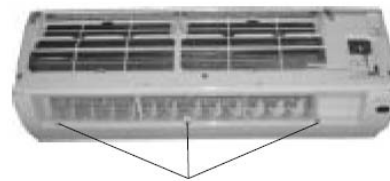

Screw

Fig.8-5

||||||| **Remove the electric box cover**

To loose the clasp which fix the electric box, to remove the electric box cover. (As shown in Fig. 8-6)

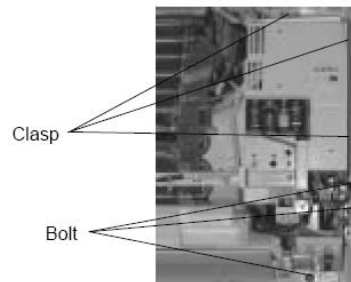

Clasp

Bolt

Fig. 8-6

||||||| **Remove the water tray sub-assy**

To pull out the terminal of the stepping motor, screw off the bolt to remove the water tray sub-assy. Because of the water drainage pipe, please be careful. (As shown in Fig.8-7)

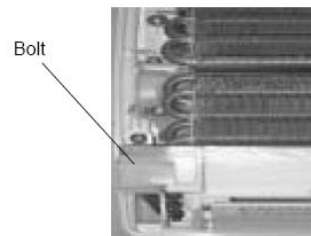

Bolt

Fig. 8-7

||||||| Disassemble the electric box

Untie the bunch of wire, to loosen the screws on electric box indicator seat, to loosen the earth screw, take out the sensor. (As shown in Fig.8-8)

Pull out each terminal, take out the control board. (As shown in Fig.8-9)

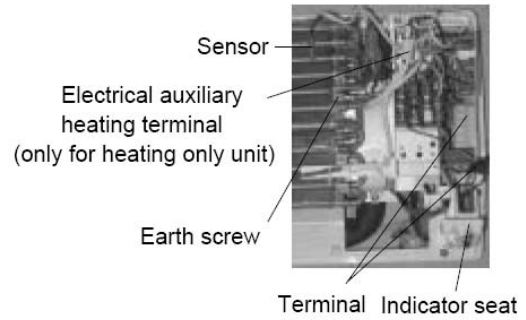

Fig.8-8



Fig. 8-9

||||||| Disassemble the evaporator

Remove the pipe clamp behind the rear case. To screw off the bolt of the rear clamp. Then press the clasp forcibly, to pull out the rear clamp. (As shown in Fig. 8-10) to screw off two pcs on the left and right side of the evaporator. To press the left nether end of the evaporator, then press it backward, to remove the evaporator side plate clasp from the slot. (As shown in Fig.8-11)

Be carefully to take out the evaporator, please take care of the connection pipe.

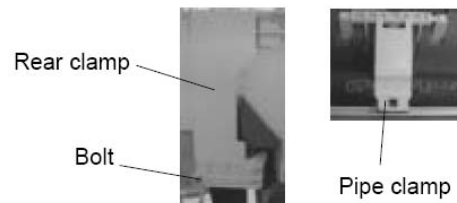

Fig. 8-10

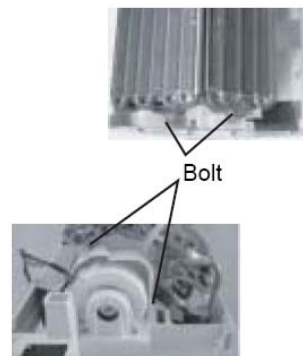

Fig. 8-11

||||| Remove the motor

Loosen the bolt which fixed the motor clamp, take out the motor clamp. (As shown in Fig. 8-12)

To loose a fixed bolt which is on the right bearing of cross flow fan, lift up the motor appreciably, then take out the motor. (As shown in Fig.8-13)



Bolt Fig. 8-12

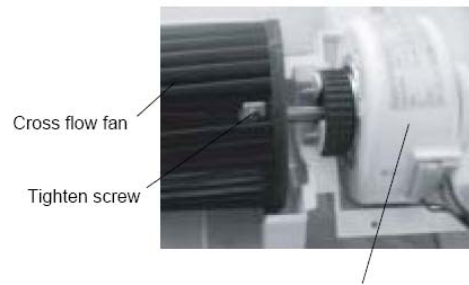

Motor
Fig. 8-13

||||| Remove the cross flow fan

Loosen one piece of bolt which fixed the cross flow fan, then can take out the cross flow fan. (As shown in Fig. 8-14)

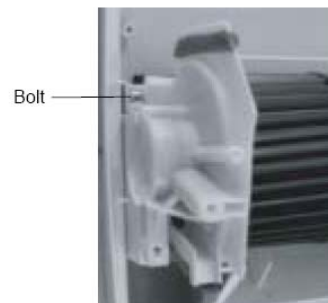

Fig. 8-14

OUTDOOR UNIT

Operation procedures/pictures

Disassemble the big handle

To screw off the tapping screw which fixed the big handle, could take out the big handle. (As shown in Fig. 8-29)



Fig. 8 — 29

Disassemble the top cover plate

To screw off 3pcs tapping screw which around the top cover, then lift it up, can take down the top cover. (As shown in Fig. 8-30)

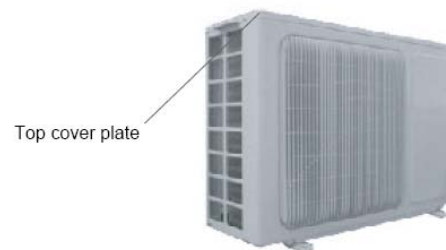

Fig. 8 — 30

Disassemble the rear grill

To screw off 4pcs tapping screw of the rear grill, can take off the rear grill. (As shown in Fig.8-31)

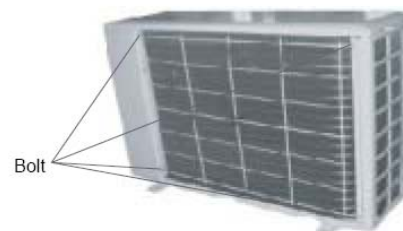

Fig. 8 — 31

||||||| **Disassemble the front panel sub-assy**

To screw off 5pcs tapping screws which come from the front panel, valve support, chassis and side plate of the condenser, then can take out the front panel sub-assy. (As shown in Fig. 8-32)

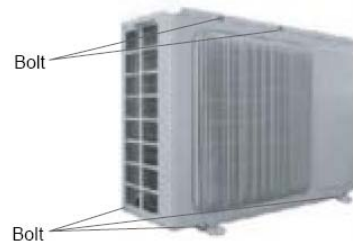

Fig. 8 — 32

||||||| **Remove the electric appliance mounting board**

To screw off 1pc bolt which fixed the electric appliance mounting board, take out the leading wire insert from the compressor and fan motor, take out the electric appliance mounting board. (As shown in Fig.8-33)



Fig. 8 — 33

||||||| **Disassemble the right side plate**

To screw off 7pcs bolt of the rear side plate, then can disassemble the right side plate. (As shown in Fig. 8-34)

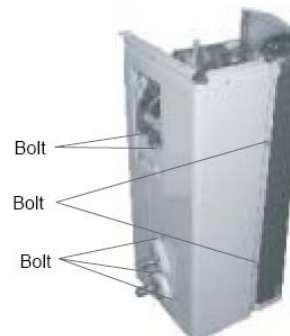

Fig. 8 — 34

Operation procedures/pictures

||||||| **Remove the axial flow fan**

To loosen tighten nut with spanner (levorotation), take off the nut, spring washer, flat washer, and take out the axial flow fan forcibly.
(As shown in Fig.8-35)

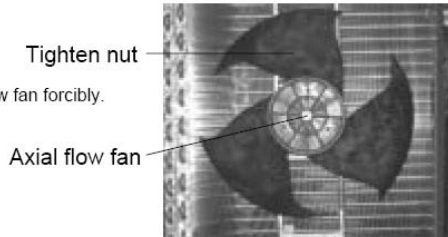

Fig. 8 - 35

||||||| **Remove the motor, motor support**

To screw off 4pcs tapping screw which fixed the motor, take out the motor. And screw off 2pcs tapping screw which fixed the motor support, lift it up, take out the motor support. (As shown in Fig.8-36)

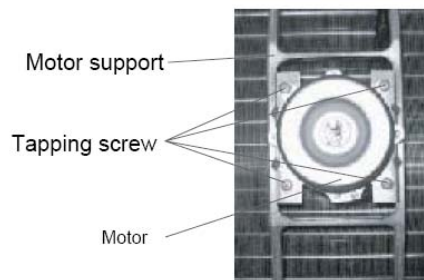
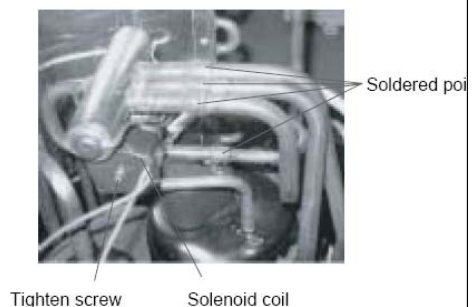

Fig. 8 - 36

||||||| **Remove the 4-way valve (Only for heating only unit)**

To screw off the tighten nut from the 4-way valve loops, then take out the loop, enwrap the 4-way vavle with wet cloth, unsolder 4pcs soldered point which connected with the 4-way valve, take out the 4-way valve.
The solder procedure should be as quick as possible, make sure that the guaze should keep wet, do not let the flame to damage the compressor lead wire. (As shown in Fig.8-37)



Disassemble capillary

Unsolder the soldered point between capillary, valve and outlet pipe of condenser, can disassemble the capillary, when changing the capillary, do not let dregs block the capillary. (As shown in Fig.8-38)



Fig. 8 — 38

Disassemble the gas valve and liquid valve

To screw off 2pcs bolt which fixed the gas valve, then unsolder the soldered point between the gas valve and air return connection pipe, take off the gas valve. (NOTE: When unsolder the soldered point, it is need to enwrap the gas valve with wet cloth, avoiding valve be damaged by high temp.)

To screw off 2pcs bolt which fixed the liquid valve, then unsolder the soldered point between the liquid valve and forked pipe, take off the liquid valve.

(As shown in Fig.8-39)

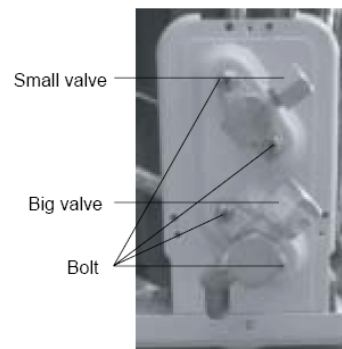

Fig. 8 — 39

||||| Disassemble the compressor

Loosen 3pcs nut with washer at the compressor button;

(NOTE: It's need to discharge the refrigerant first.)

Unsolder the soldered points of air in pipe and air out pipe,
remove the pipeline carefully, take out the compressor.

Cooling only unit (As shown in Fig. 8-40)

Cooling and heating unit (As shown in Fig.8-41)

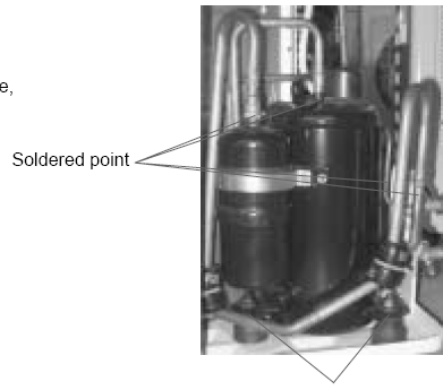

Nut with washer

Fig. 8 — 40

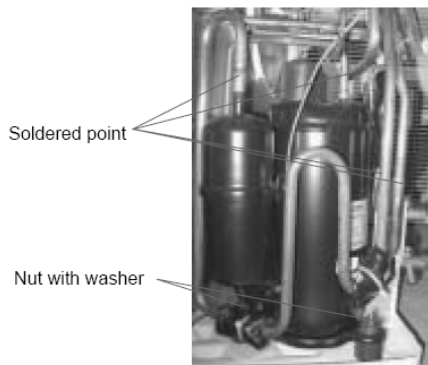
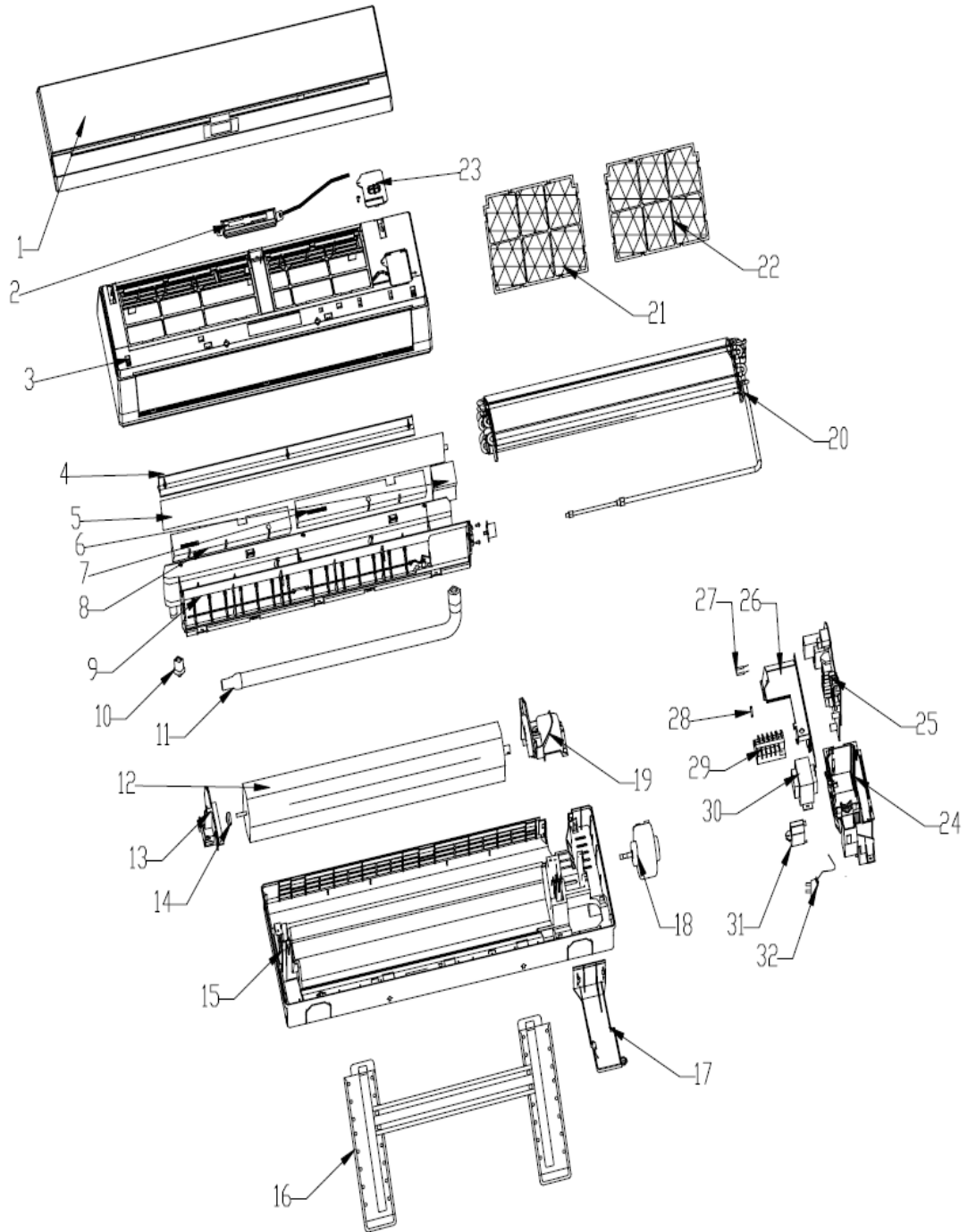

Fig. 8 — 41

EXPLODED VIEW – Indoor Unit



PART LIST – Indoor Unit

No.	PART NAME
1	FRONT FRONT COVER ASSEMBLY
2	FIXED PLATE
3	MEDIAL PLATE ASSEMBLY
4	WIND-GUARD ASSEMBLY
5	FLAP
6	FOAM
7	FOAM
8	FOAM
9	AIR GUIDING
10	WATER BLOCKAGE
11	DRAINAGE PIPE
12	FAN
13	LEFT BRACKET
14	BEARING ASSEMBLY
15	CHASSIS ASSEMBLY
16	SUPPORT PLATE
17	TUBE PLATE
18	FAN MOTOR
19	RIGHT BRACKET
20	EVAPORATOR
21	LEFT AIR FILTER
22	RIGHT AIR FILTER
23	ELECTRIC COVER
24	ELECTRIC BOX (BELOW)
25	P.C.B. ASSEMBLY
26	ELECTRIC BOX (UPPER)
27	THERMISTOR ASSEMBLY
28	FUSE
29	TERMINAL BLOCK
30	TRANSFORMER
31	ANION EMITTER
32	POWER CORD

EXPLODED VIEW with PART NAME – Outdoor Unit

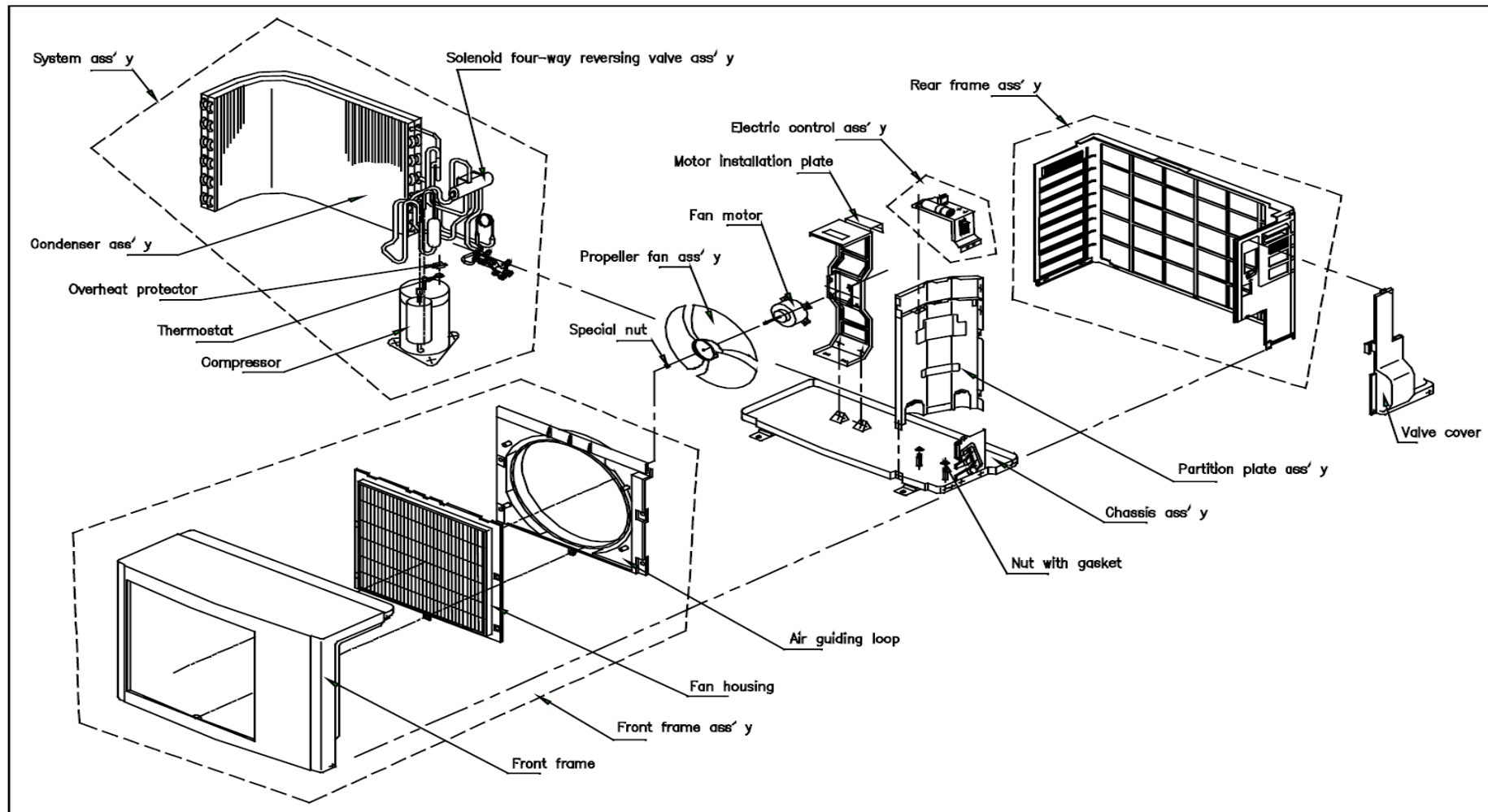

GUIDE FOR INSTALLATION

1 Indoor Unit

- The air intake and outlet vent should far away from obstruction so that air can be blown to the entire room;
- Place where is easy to drain condensate and connect with outdoor unit;
- Far way from heat source, steam and flammable gas;
- Place where can stand the weight of indoor unit without increasing the running noise and shakes.
- Ensure the installation of indoor unit fits requirements on install dimension diagram.
- Ensure there is enough space for maintenance or repair, height of indoor unit to floor should over 200cm;
- Place the units to where there is 1m or more away from TV, hi-fi and other appliances;
- Place where air filter can be easily taken out;

2 Outdoor Unit

- Place where noise and outflow air produced when exhausting would not disturb neighbors;
- Place where there is well ventilation, ensure outdoor unit enjoys well ventilation;
- There should not be obstruction near air intake and outlet vent of outdoor unit;
- The installation place should be able to stand the weight and shake of outdoor unit and ensure safe installation;
- Place where there is no leakage of flammable or corrosive gas;
- Ensure the installation of outdoor unit fits requirements of dimension diagram.

Notice:

Installation in the following places may cause malfunction; if it is unavoidable to install unit there, please contact our service center.

- Place where there is machine oil
- Saline and alkaline place where is near sea
- Place where there is sulfured gas (such as sulfured spring)
- Place where there is high-frequency equipments such as radio, welders and medical equipment
- Place where with special environmental conditions



INDOOR UNIT

1) Install Rear Panel

- Measure horizon position by hanging line. Since drainage pipe is on left side, it is better to adjust left side lower.
- Fix rear plate on wall by bolts.
- Confirm if it is firm enough by pulling it by hand. The rear panel after installation should be able to stand the weight of an adult (60kg), and the weight should be evenly shared by each screw.

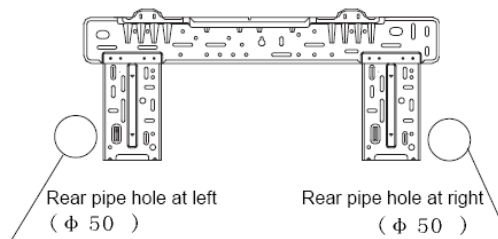

Fig.11-1

2) Make Piping Hole

- As shown in fig.11-2, pipe can be led out by 6 directions each of which can be selected in necessity.
- After confirming piping hole location by following fig.11-1, drill an outward slant hole on wall (φ 50).
- In order to protect pipe and cable from damaging when going through wall, install piping hole sleeve.

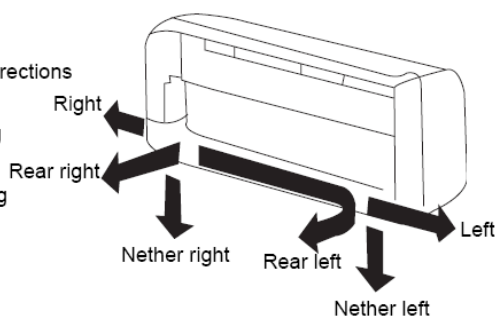

Fig.11-2

3) Install Drainage Hose

- Drainage hose must be placed as slant downward mode for smooth drainage.
- Do not wrench, bend or heave the drain hose or flood its end into water (As shown in fig.11-3).
- When passing indoor unit the prolonged drainage hose would be wrapped heat insulating material.

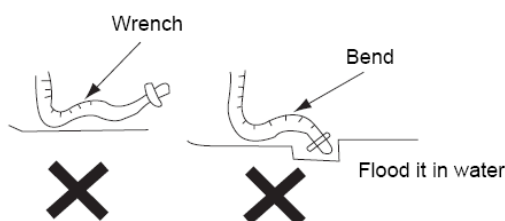

Fig. 11-3

4) Install Connecting Pipe

Connect the connecting pipe with the 2 lead pipe from indoor unit correspondingly, tighten joint nut of the connecting pipe (Refer to the following Install Connecting Pipe).

Notice:

- Connect the connecting pipe with indoor unit first and then outdoor unit.
- The arrange of bending of pipe should be carefull and don't damage the connect pipe.
- Joint nut should be screwed too tight, ot leakage would occur.

5 Electric Wiring

1. Open panel upwardly.
2. Disassemble wiring cover.
3. Lead power connect cord goes through by wire holes at chassis and bottom of electric box from down to upper side.
4. Connect the blue one among power connect cord onto terminal N(1) of terminal board, brown one onto terminal 2, and yellow-green one (i.e. earth wire) onto terminal \perp .
5. To heat pump unit, signal connect cord (2×0.75) should be connected with indoor unit by connector (as shown in fig.11-4), and tighten the signal control cord by wire clamp at button of case.
6. Install wiring cover to its original place.
7. Cover panel to its original place.

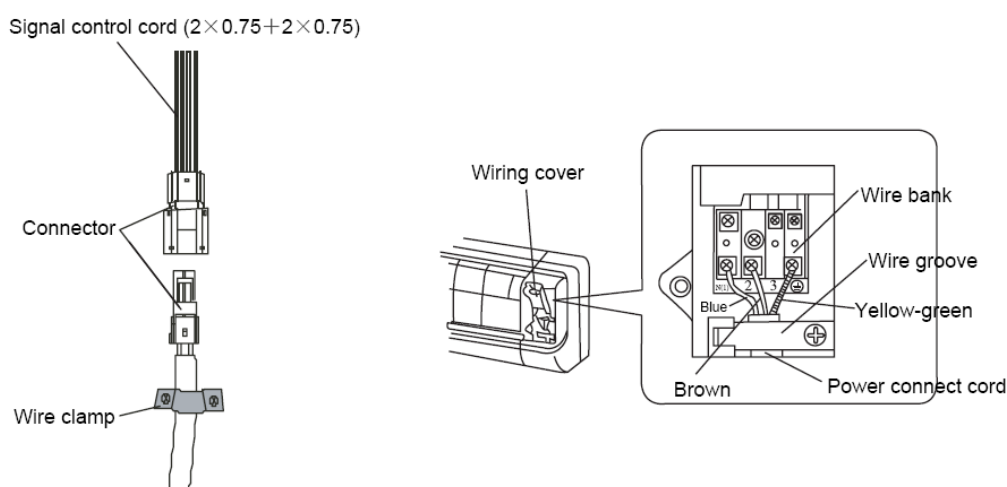

Fig.11-4

Notice:

- Since one terminal of power connect cord had been connected with unit, when testing by electrified single unit, another terminal of power connect cord may carry electricity, please conduct insulation to prevent circuit short or electricity leakage.

Notice:

- All electric installation must be done by professional personnel by following local law, regulation and this manual.
- Power must adopt rated voltage and special circuit for air conditioner.
- Do install electric leakage protector.
- If power cord is damaged, in order to prevent dangerousness, please do have it changed by manufacturer, after sales service agent or relevant professional personnel.
- Diameter of power cord should be big enough, do exchange the damaged power hose and connect hose by special hose.
- Installation should be conducted according to national wiring regulation.

6 Install Indoor Unit

1. Piping mode of indoor unit refer to right fig.11-5(a) and (b).When routing the piping and wiring from left or right side of indoor unit, cut off tailings from base of host in necessary as shown in fig.11-5 (c).
- (1) Cut off tailing 1 when only power cord is led;
- (2) Cut off tailings 1 and 2 (or 1, 2 and 3) when connecting pipe and cord is led; ①, ② and ③ are recommended piping modes.
2. After wrapping pipes and wires, make them though pipe hole (as shown in fig.11-6).
3. Hang the mounting slots that behind indoor unit on the hooks of the rear panel and check if it is firm enough. As shown in fig.11-7.
4. Install height of indoor unit should be higher than 2m.

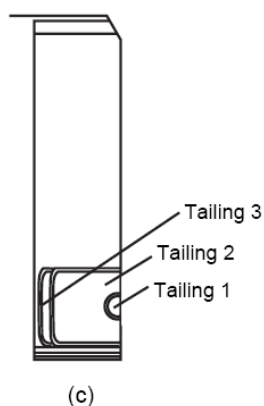
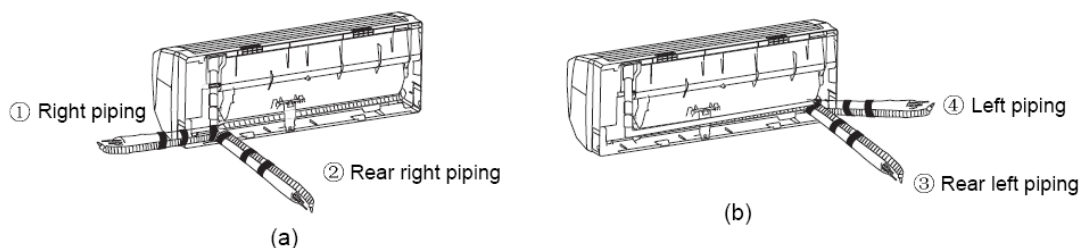

Fig.11-5

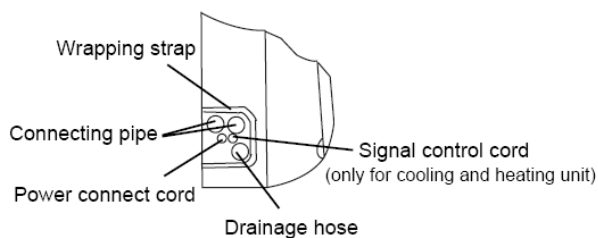

Fig.11-6

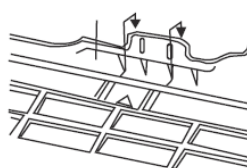

Fig.11-7

OUTDOOR UNIT

1 Install Connecting Pipe

- Align the flare of connecting pipe with corresponding valve joint interface.
- Tighten the nut of connecting pipe forcibly, then tighten it by spanner (as shown in fig.11-8).

Notice: Too great of torque would damage nut.

Refer the following list for tighten torque

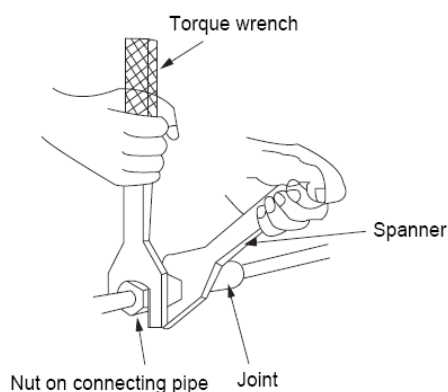

Fig.11-8

Hex nut	Tighten torque (N·M)
Φ 6	15 - 20
Φ 9.5	31 - 35
Φ 12	50 - 55

2 Wiring Connection

- Take off big handle at right side plate of outdoor unit (1 bolt).
- Take off wire clamp, connect and fix power connect cord to terminal of wire bank. Wiring should fit that of indoor unit.
- Fix power connect wire by wire clamp. To cooling and heating unit, fix signal control cord by clamp then connect corresponding connector.
- Ensure if wire had been fixed well (Fig.11-9).
- Put on handle (tighten by 1 bolt).

Notice:

- Wrong wiring would cause malfunction on some electric components.
- After fixing cable, ensure that there is some space for leads between connecting place and fixing place.

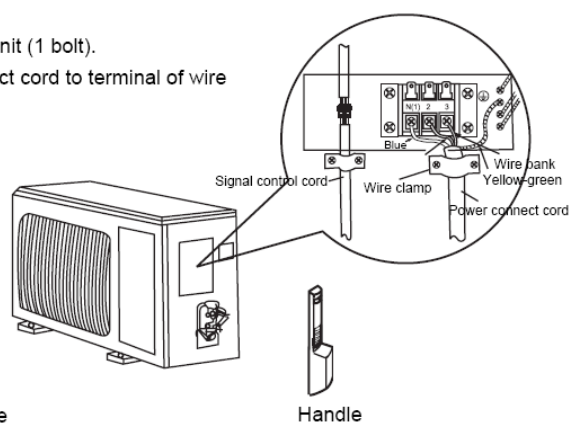

Fig.11-9

3 Vacuumization and Leakage Detect

- Take out nut cover on cut-off valve on outdoor unit.
- Align center of pipe, tighten taper nut completely by hand.
- Tighten taper nut by hand.
- Take off valve covers and freon charge nozzles on both liquid valve and gas valve
- Screw out core of liquid valve by hex spanner, prize core on gas valve by screwdriver at the same time and gas should be exhausted at that time.
- When exhausting for about 15s, refrigerate gas may appear. Close gas core and tighten nut of freon charge nozzle.
- Open cores of liquid valve and gas valve completely (fig.11-10).
- Tighten valve cover, then check if leakage occur at indoor and outdoor unit and connect part of pipe by soapsuds or leakage detector.
- If it is possible, exhaust air in unit from gas core by vacuumize pump (fig.11-11).

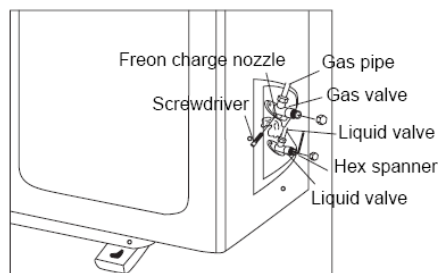

Fig.11-10

Process are as following:

1. Take off nut cover on freon charge nozzle on gas valve.
2. Connect the middle charge host of vacuumize meter to vacuumize pump, connect Lo terminal onto charge nozzle of gas valve.
3. Start vacuumize pump to begin vacuumizing. When circuit tester indicates at 1 bar, close Lo handle completely on vacuumize meter to stop vacuumizing. Maintain it for more than 15 mins, ensure pressure on vacuumize meter remains still.
4. Take off bonnet on gas valve and liquid valve.
5. Loosen core of liquid valve a little by hex spanner till pressure on vacuumize meter rise to more than 0 bar.
6. Take off charge hose from charge nozzle of gas valve, tighten cut cover on the charge nozzle.
7. Turn on core of gas valve and liquid valve completely by hex spanner.
8. Tighten bonnets on both gas valve and liquid valve and check if there is any leakage.

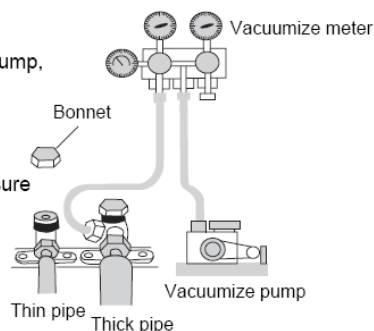

Fig.11-11

4 Drainage of Outdoor Unit Condensate
(Only for Cooling and Heating Unit)

- When unit is heating, condensate produced by outdoor unit and defrost water when defrosting would be drained to proper place by drainage hose.

Install method:

- Insert outdoor drainage joint into hole $\phi 25$ at chassis as shown in fig.11-12, then connect the hose onto drainage nozzle can drain condensate and defrost water to proper place.

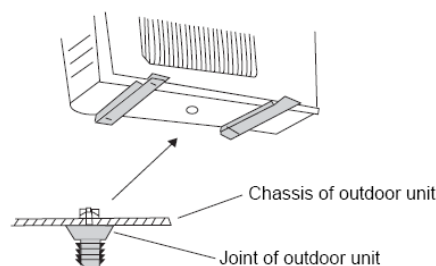

Fig.11-12

TRIAL RUN AFTER INSTALLATION

1 Trial Run

1. Preparation for Trial Run

- Don't turn on power before all installation are completed.
- Control circuit should be connected correctly, all wire connection should be firm.
- Cut-off valve on thin and thick pipe should be turned on.
- All scattered things, especially scrap and wire etc, should be taken out from the unit.

2. Trial Run Method

- Connect power and press ON/OFF on wireless remote control then unit begins operating.
- Press MODE to select run modes of COOL, HEAT or FAN to see if operation is normal.
- Emergent operation, when wireless remote control is missing, conduct the following methods:
 - (1) When unit is off, press button ON/OFF then unit be in auto run state. Microcomputer would select modes of COOL, HEAT or FAN automatically to make comfort. Repress the button to stop unit from operating.
 - (2) Under operating state, press button ON/OFF to stop unit from operating.

2 Check after installation

Check Items	Possible Malfunctions
Is the installation firm enough?	Unit may drop, shake or emit noise
Is leakage test done?	It may cause insufficient of refrigerating (heating) capacity.
Is heat insulation sufficient?	Condensation or water drop may occur
Is drainage smooth?	Condensation or water drop may occur
Is power voltage the same with that listed in nameplate?	Malfunction or burn out of parts may occur.
Is installation of circuit and pipeline correct?	Malfunction or burn out of parts may occur.
Is unit earthed safely?	Electric leakage may occur
Is wire model fits relative regulation?	Malfunction or burn out of parts may occur.
Are air inlet or outlet vent of indoor and outdoor unit blocked?	It may cause insufficient of refrigerating (heating) capacity.
Are length of refrigerant pipe and charge volume of refrigerant recorded?	It will be hard to handle the charge volume of refrigerant.

CARE & MAINTENANCE

Warning

- Do stop the unit and plug out power plug before cleaning the unit, otherwise electric shock may occur.
- Don't get the unit wet for it would cause electric shock. Ensure that the unit would not be rinsed by water under any circumstance.
- Volatile liquid like thinner or gasoline would damage the appearance of air conditioner (only adopt soft dry cloth and wet cloth with neutral scour when cleaning air conditioner appearance).



Clean Panel

1 Take out panel

Pull the grooves on both ends of panel at the same time forcibly to place shown on figure by arrow direction then take off panel.

2 Clean Panel

Clean it by moist soft brush and neutral scour, then wipe it with water and dry it.

3 Install Panel

Put the props on both ends of panel into fulcrum groove and put middle rotate shaft into groove, then cover the panel cover well by arrow direction.

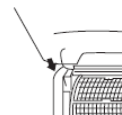

Clean Air Filter

1 Take off Air Filter

Pull the panel to an angle forcibly at grooves at both ends of panel contemporarily by the arrow direction, then take off air filter by pulling it downward. As shown in right figure.

2 Clean Air Filter

Adopt dust cleaner or water to wash filter. If the filter is very dirty (like oil spots on) wash it by warm water (lower than 45°C) that dissolved with neutral cleanser, then dry the filter on shade, as shown in right filter.

3 Install Air Filter

Install air filter well by arrow direction, let its side that marked "Front" faces you then cover and buckle the panel well.

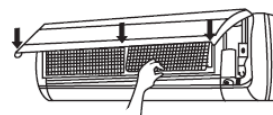
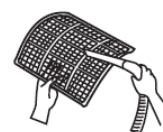
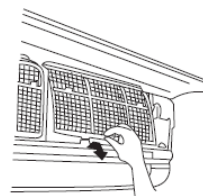

Notice:

Don't dry the panel or air filter directly under sun burn; don't wash them by hot water which is hotter than 45°C or burn it on fire (For these would cause fade, fire or deformation).

MULFUNCTION ANALYSIS

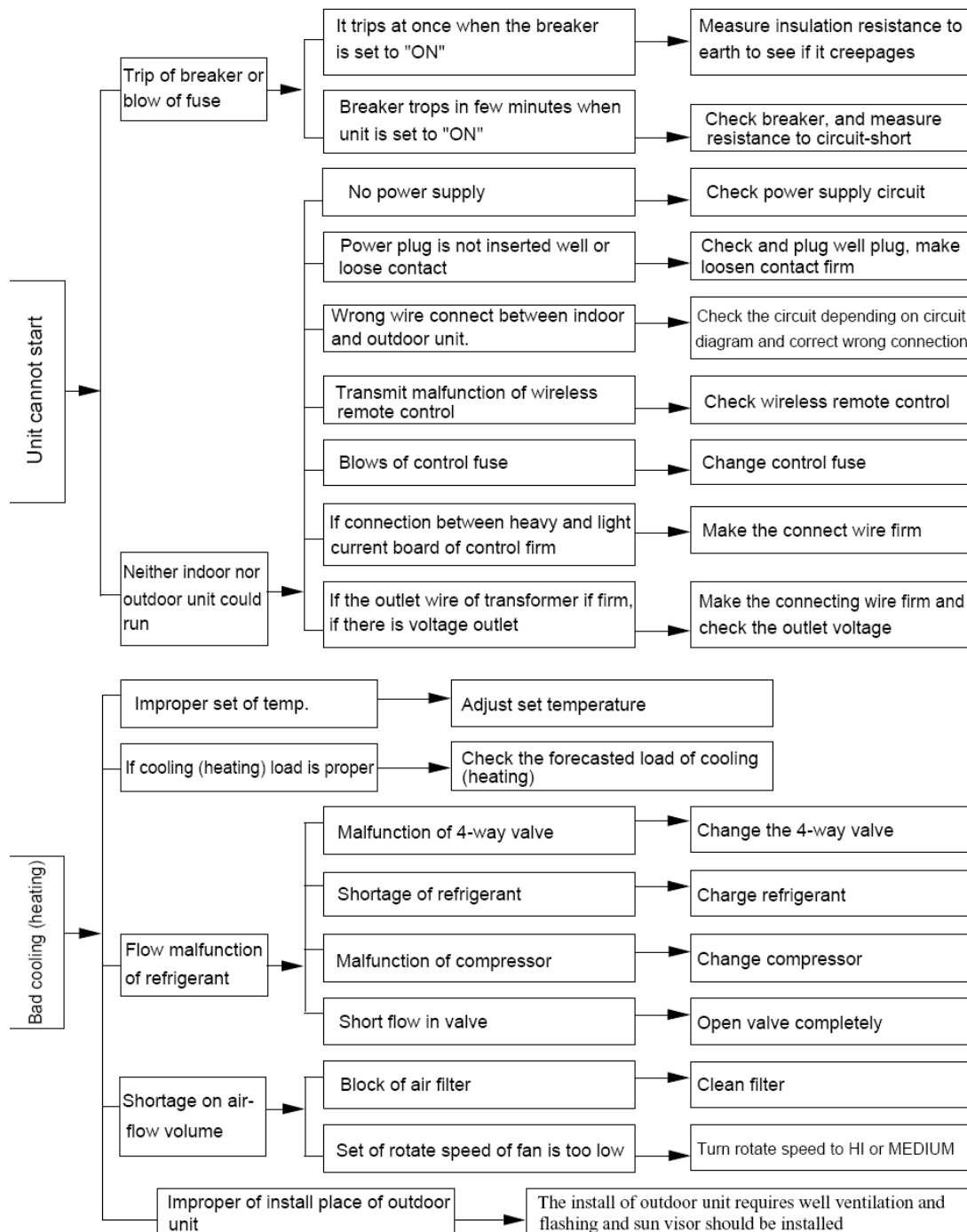

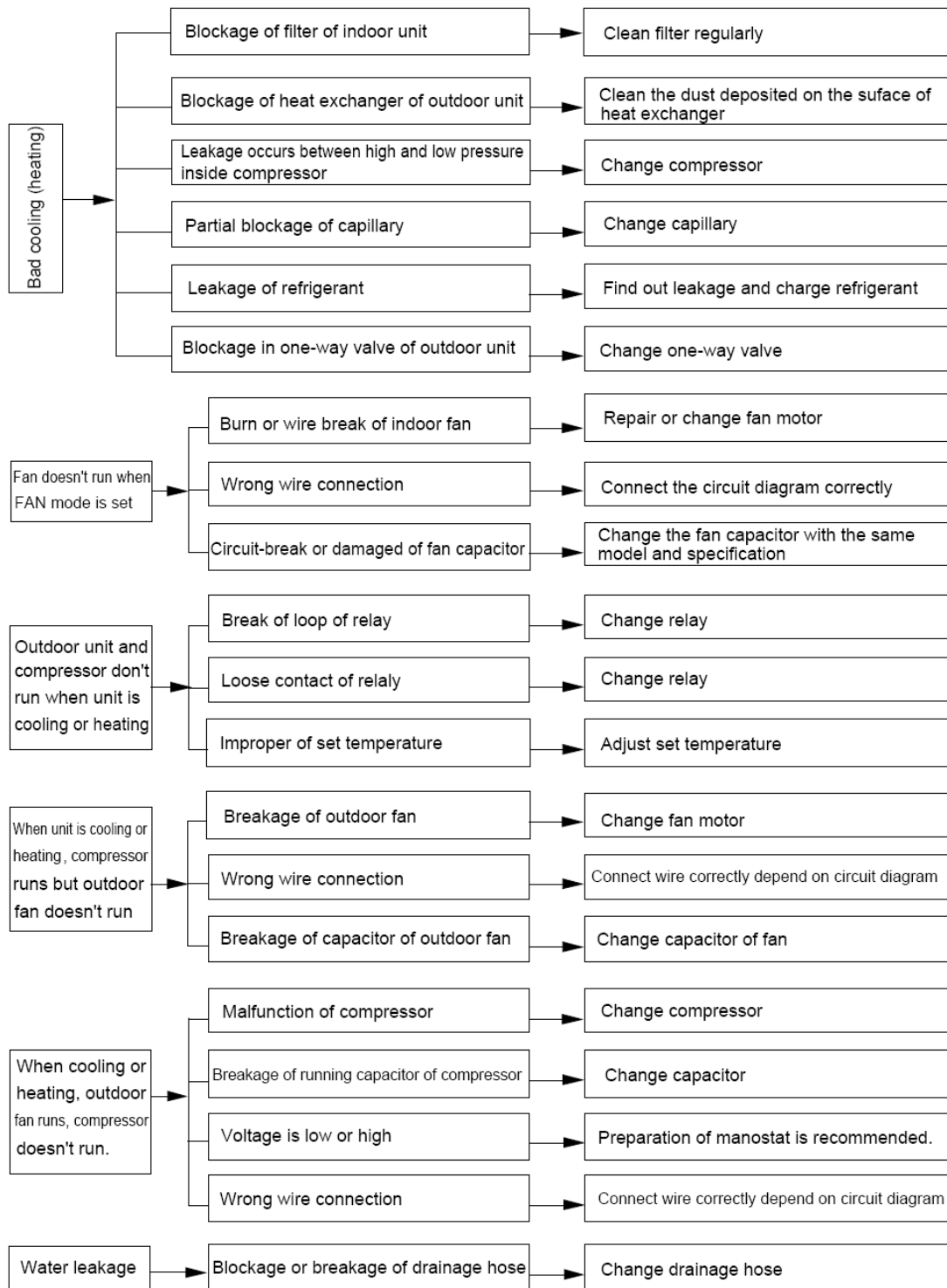

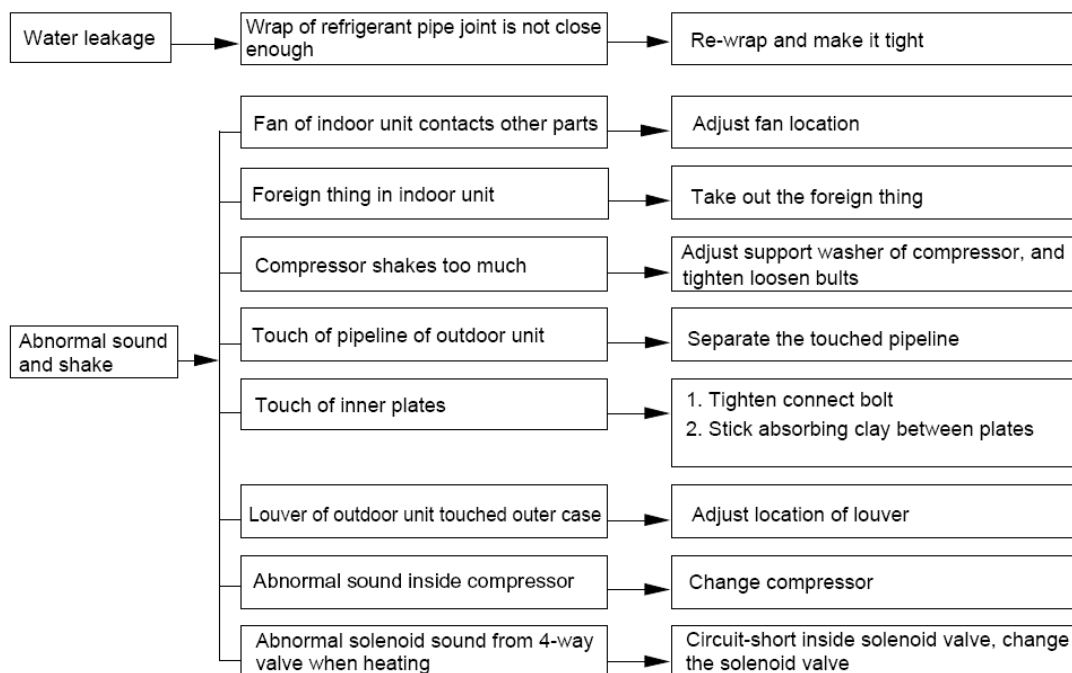



Большая библиотека технической документации
<https://splitsystema48.ru/instrukcii-po-ekspluatacii-kondicionerov.html>
каталоги, инструкции, сервисные мануалы, схемы.